

DRIVING ILLUSTRATION

125 - E MANUAL

Preface

Thank you for choosing our motorcycle , we design, test, and manufacture this motorcycle through our advanced technologies, so that you will have more safety and fun on driving , After finish reading every item in this manual, you will find driving motorcycle is an exciting sport, and from which you can enjoy beautiful feelings.

This manual provides general information of maintenance and service for this motorcycle. As long as you observe maintenance guideline in this manual, your motorcycle may have long service life and avoid faults. Depending on professionally trained technicians and complete tools as well as perfect equipment, our distributors will provide you with best repair and after service.

All data included in this Manual, such as illustration, picture and technical parameter, are based on latest Products when this Manual is released. However, as a result of continuous improvement of products and variation on other aspects, your motorcycle may be different form this Manual. Therefore, our distributor will guide you correctly at any time.



Copyright © GUANGDONG TAYO MOTORCYCLE TECHNOLOGY CO., LTD
All Rights Reserved.

Any republication, copy and extract of this manual shall not be allowed
without writing authorization of GUANGDONG TAYO MOTORCYCLE
TECHNOLOGY CO., LTD.
Please contact the local authorized dealers for this manual.

Content

Summarize

Instruction to user -----	1
About information of security -----	2
Safety instruction for driver's operation -----	2
Number position -----	3
Mounting positions of components and parts -----	4
Control	
Key -----	6
Ignition switch -----	6
Lock handle bar -----	6
Meter panel -----	7
Left handle control system -----	8
Right handlebar switch -----	9
Parking stand -----	10
Fuel switch -----	11
Gear shift lever -----	12

Rear brake pedal -----	12
Starting lever -----	12
Tool kit -----	13

Driving

Knowledge in respect of motorcycle running in -----	13
Key points of operation -----	13
Check prior to operation -----	14
Start- up of engine -----	15
Running -----	15
In the case of variable speed gear -----	15
Climbing up -----	16
Brake and stop -----	16

Troubleshooting

Running in of new motorcycle -----	17
Use instruction for fuel and engine oil -----	18

Content

Regular maintenance -----	19
Battery -----	21
Air filter -----	22
Spark plug -----	23
Fuel filter element cleaning or changing -----	24
Machine oil -----	24
EFI system -----	26
Adjustment of throttle dragline -----	27
Clutch -----	27
Transmission chain -----	28
Rear spring adjustment of shock absorber -----	29
Maintenance and service of silencer -----	30
Brake system	
Combined Brake System -----	30
Brake oil -----	31
CBS brake -----	32
Brake indicator switch -----	33

Tyre

Tire pressure -----	34
Tyre damage -----	34
New wheel and tyre -----	35

Electric system

Replace bulb of front light -----	35
Replace bulbs of front and rear indicator lights -----	36
Taillight and stoplight is replacing -----	36
Cartridge fuse -----	37
Use instruction for storage battery -----	37

Troubleshooting

Troubleshooting -----	39
Specification table -----	40
Circuit diagram -----	41
Abbreviation form -----	42

Instruction to user

Various parts in the market may be available to your motorcycle. We cannot directly control their quality and suitability. Inapplicable parts may threaten driver's safety. Although we cannot check applicability of marketable parts one by one, your distributor can help you select high-quality parts and install them in your motorcycle correctly.

In order to enable you to select and install parts carefully and properly, we provide you with selection and installation criterion for your reference, on which you may rely to determine specification and installation method of accessories.

(1) Accessories over-weighted or susceptible to wind should be mounted as low as possible to attach to body closely and be close to center of gravity. Carefully check storage rack and accessories for firm installation. Improper installation may cause centre of gravity shift to result in safety danger. Key point of accessory installation is :balance between left and right sides, firmness and stability.

(2) Check accessories to be installed for proper height from the ground and inclination angle. Improper installation may lower two safety factors. Special attention should be paid to avoidance of damage to functional system such as shock absorber, direction indication and control etc.

(3) If accessories are mounted in steering handle or front fork, serious unbalance may occur. This impairs steering sensitivity to cause vibration of front wheel and unstable drive. In the case of accessories mounted in steering handle or front fork, their weight shall be minimized.

(4) Wind screen, backrest, saddle bag, and travelling case etc are susceptible to wind, thus causing unstably driving. This is apparent expressly in the case of side wind or heavy wind arising from heavy-duty vehicles. Therefore, improper installation and design of accessories may threaten life. However, special attention must be paid to selection and installation of accessories.

(5) Some accessories makes driver's seat deviate from normal position. This restricts driver's operation range, but also his / her operational capacity.

(6) Electrical accessories beyond specified specification may cause overloaded electrical system. In the event of high overload, wiring might be damaged or wires disconnect to cut off power; as a result, to cause danger.

About information of security

Read and observe this Manual carefully. These terms such as 'warning' 'Caution' and 'Notice' are used to emphasize intensity of precaution. Please study and understand their meanings thoroughly.

Warning

For warning information, in order to protect you and other people's safety as well as avoid damaging your motorcycle, this precaution must be read.

Caution

It is notice information; In order to extend service life of your motorcycle and exert its performance well, please carry out according to notice information.

Notice

It can help you to use your motorcycle in best of all condition based on its useful information.

Safety instruction for driver's operation

Driving motorcycle is an enjoyable and exciting sport. You must comply with following instruction to assure your safety:

Wear safety helmet

It is preferred to select safety helmet in conformity to safety quality standard. Worst traffic accident may cause head injury. Therefore, you must wear safety helmet and safety glasses while driving motorcycle.

Safety clothing

Loose and bizarre clothing is uncomfortable and unsafe. Tight clothing should be selected as possible while driving motorcycle.

Be familiar with motorcycle

Your operation skill and mechanical knowledge will ensure safe operation. You'd better carry out practice repeatedly in an open field till you are able to be familiar with mechanical property and operation method of motorcycle. Keep in mind! Skill Comes From Practice.

Know your operation skill

You must operate your motorcycle skillfully within required technical specification to avoid accident.

Precautions in overcast and rainy weather

In the case of overcast and rainy weather, pay special attention to brake. However, keep in mind: braking distance in overcast and rainy weather is twice that in fine weather. While driving your motorcycle in overcast and rainy weather, you must avoid some slipping sections on road surface, such as marking paint, wellhead cover, oily area to prevent your motorcycle from slipping off. Pay special attention to driving when passing through railroad junction, grill and bridge. Should it be impossible to judge the conditions of road surface, you have to decelerate.

Reconstruction

Reconstruction or disassembly / assembly of prototype parts without permission will violate safety warranty and be illegal, thus resulting in unsafe operation. Drivers must comply with motorcycle operation provisions stipulated by Traffic Authority.

Reconstruction

Reconstruction or disassembly / assembly of prototype parts without permission will violate safety warranty and be illegal, thus resulting in unsafe operation. Drivers must comply with motorcycle operation provisions stipulated by Traffic Authority.

Number position

Vehicle ID number (VIN) and number of engine are used for registration of a motorcycle. When ordering parts or entrusting special service, your distributor may provide you with better service according to these numbers.

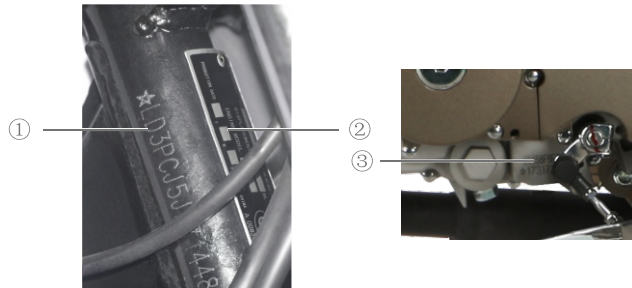

① Vehicle ID number (VIN) ② Nameplate on rack ③ Number of engine

Vehicle ID number (VIN) ① and nameplate ② are imprinted on vertical steering pipe; number of engine ③ is imprinted on left side of crankcase.

Please record these numbers in corresponding blank for later reference.

Vehicle ID number (VIN):

Number of engine:

Mounting positions of components and parts

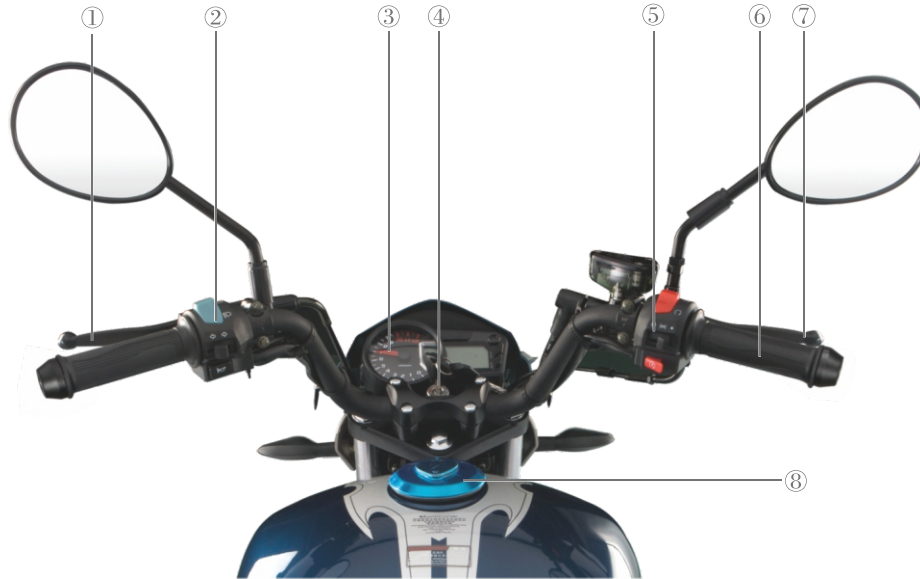

(1) Clutch handle

(5) Switch on right handle

(2) Switch on left handle

(6) Accelerator control handle

(3) Meter

(7) Front brake handle

(4) Electric door lock switch

(8) Cover of fule



(9) Muffler

(10) Rear disc brake
(Rear brake panel)

(11) Start crank

(12) Oil level

(13) Rear brake pedal

(14) Ignition coil



(15) Front disk brake

(16) Gearshift pole

(17) EFI system
(Carburetor choke valve)

(18) Main stand

Side stand

Control

Key

This motorcycle is provided with two keys, one of which should be kept properly for standby.



Ignition switch

Ignition switch is available to two positions:

„⊗ „ (OFF position)

All circuits are in open-circuit state.

„⌚ „ (ON position)

All circuits are connected to be ready for ignition. However, key must always be inserted in place in the case of this position.

Lock handle bar

Turn the key to the lock handle bar position to stop the motorcycle. In this case, the key may be taken off, but the handle bar cannot be turned freely; hence assuring safety in the absence of driver.



Warning

- Before turning the key to the lock handle bar position, you must stably support the motorcycle by means of the side stand or main stand.
- When the steering mechanism is locked, never move the motorcycle to avoid imbalance.

Meter panel



① Oil level indicator

This indicator shows oil level in oil tank.

② Speed meter

Speed meter indicates running speed in km/h or mph.

③ Odometer / Mileometer

Odometer records total mileage as from operation commencement. Mileometer is a kind of odometer returnable to zero. It is used to record short distance mileage or roughly estimate fuel consumption.

④ Clock

This clock displays the current time.

⑤ Buttons

- Shortly press SELECT button, the mileage number will be shown on the mileage table of “Total” and “Trip” .

- On the mode of “Trip” , press the SELECT button for a long time, the taximeter will go back to zero.

- Shortly press ADJUST button, the speed mileage unit will be shifted between KM/H and MPH

- On the mode of TOTAL, press SELECT for a long time, the hour unit of the clock ④ will twinkle, shortly press ADJUST button, we can add hour(1-12), and we can continually press the SELECT button, the minute unit will twinkle, shortly press ADJUST button, then we can adjust to add minute (00-59), continue to long press SELECT button to exit.

- To press for a long time $\geq 2s$, press shortly $< 2s$

⑥ High beam indicator

When turning on headlights on full beam, the indicator will enable blue lamp.

⑦ Shift indicator

Shift indicator shows shift position, i.e. 1,2,3,4 and 5. While changing over shift, they light by turns. When changing to neutral position, all indicators go out, but neutral position (green) lights.

⑧ Steering indicator

When steering signal switch is set to left or right side, the indicator will flicker.

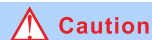

If the turning light switch is operated, the indicator will flash.

⑨ Error indicator

When turning on the ignition switch with the key, this indicator is on for 3 seconds, and then it will be off. When error occurs, indicator is on until problem is solved.

Caution

If indicator is on during your riding, please stop and check the motorcycle. Do not ride again before problem is solved.

⑩ Neutral position indicator

When gear shift is in neutral position, this indicator lights; when in any position beyond neutral position, this indicator goes out.

⑪ Tachometer

Tachometer indicates rate of revolution (rev) of engine, i.e. revolutions per minute.

Left handle control system

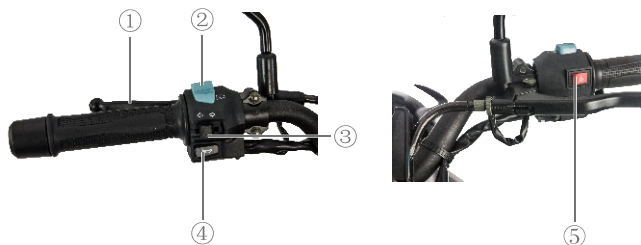



① Clutch handle



When starting up engine or changing shift, hold this handle to separate clutch friction disk, hence cutting off power.

② Dimmer switch

High beam / city beam operation

When dimmer switch is set to  position, high beam is enabled; in the meanwhile high beam indicator on the panel lights. When the switch is set to  position, city beam is enabled and high beam is disabled.

③ Steering signal operation

When this switch is set to left , left turning indicator lights; when set to right , right turning indicator lights. In the meanwhile, steering indicator on the panel flickers.

④ Horn button

Press this button to make horn sound.

⑤ Danger-warning switch

Press this button, the four lights are flashing, and warned nearby vehicles to pay attention to the safety.

Warning

Before changing lane or turning round, driver must give turning signal. After changing lane or turning round, driver must turn off steering light.

Right handlebar switch



① Shut down switch

Switch the engine stop button

② Front brake handle

When enabling front brake handle, firmly hold brake handle on right side. Because of hydraulic disk brake, high holding force isn't needed while braking. When holding brake handle firmly, brake indicator will light automatically.

③ Accelerator control handle

Accelerator control handle is used to control rev (rate of revolution) of engine. When turning this handle inward (to yourself), the engine accelerates; contrarily, when turning it outward, the engine decelerates.

④ Start-up button

Press this button to switch on starting circuit. When starting up, you must set shift to neutral position, confirm if engine flameout switch is in "⌂" position, and hold clutch handle to ensure safety.

Warning

In the case of continuous start-up, each starting time cannot exceed 5min because considerable discharge makes the circuit and starting motor heat abnormally. In the event that the engine cannot start up after several trial runs, you should check oil supply system and starting circuit system. (please refer to Section 1 "Troubleshooting")

The danger-warning switch shall be used only when the vehicle stops to work for the malfunction on the road. Never open it when driving normally.

Parking stand

This motorcycle is equipped with main stand and side stand. When using main stand, you should pedal on main stand meanwhile your left hand holds steering handle and right hand holds rear storage rack, and then pull the motorcycle backwards to support it stably.



① Main stand ② Side stand ③ Rear armrest

Warning

Rear storage rack bears up to 5kg load; otherwise overload may impact stable driving; thus resulting in danger and damage to the rack.

Side stand Prior to starting up, check these stands for upper limit positions.

Gear shift lever

This motorcycle is equipped with 5- shift geared- transmission shown as right figure. Gear lever ① is connected with ratchet mechanism in the geared- transmission. After one shift is enabled, the lever will automatically return to original position to change over to next shift. Under neutral position condition, Ratchet mechanism cannot enable two shift forwards and backwards at same time. However, neutral position shift 1 and 2.

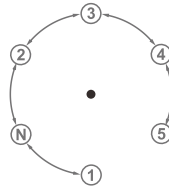
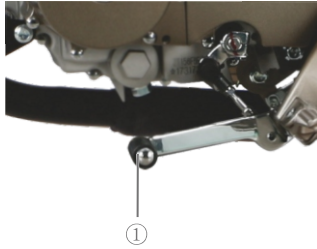

International Gear

Before changing to lower shift, you should decelerate to drive. Before the lower shift is enabled, you hold clutch handle to increase rev of the engine; hence preventing components and parts of drive system and rear wheel from wearing out unnecessarily.

Caution

In the case of neutral position, when neutral position indicator lights, you had better release clutch handle slowly to confirm if neutral position is really available.

Rear brake pedal

When pressing the brake pedal ①, rear brake works. When operating rear brake, brake indicator lights.



Starting lever

This motorcycle is equipped with kick- back starting lever ① on right side of the engine. Because of pedal kick- back starting mechanism, the engine can start at any shift level when the clutch doesn't engage.

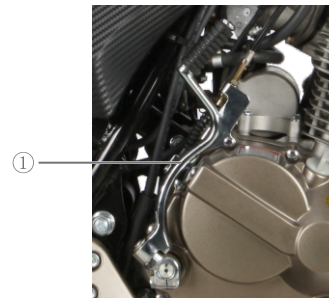

Tool kit

Tool case is under the seat. Tools can be take out after the seat is lifted.



Driving

Knowledge in respect of motorcycle running in

For this model, 1000 km initial driving mileage will play the most important role in service life of a motorcycle. During its running in period, running in of motorcycle correctly enables it to have longest service life, but also brings its performance into play sufficiently. All components and parts used in this model Motorcycle are made of high quality materials and machined in precision manner. Correct running in makes all parts used in a motorcycle work with each other and engage smoothly.

Motorcycle running in properly and effectively enables it to drive stably, thus bringing its high performance into play sufficiently. Special attention should be paid to avoid overheated in engine.

Refer to 'Maintenance' section for detailed information on running in method.

Key points of operation

- If you drive this motorcycle for the first time, we recommend you'd better practise how to drive it on a non-service road till you are sufficiently familiar with its control method and operation method.
- No single hand operation is allowable because this is very dangerous. Your both hands should hold the handle and your both feet step on pedal while driving the motorcycle. In no case, your hands release from the handle to drive the motorcycle.
- Don't brake forcedly while turning, you should decelerate to safe speed prior to turning instead.
- In the case of wet and smooth road surface, braking capacity and turning capacity will decrease naturally due to low force of friction; hence you have to decelerate in advance.
- Crosswind occurs at tunnel exit most frequently. You must pay attention to driving speed while you are passing through valley or heavy-duty vehicle.
- You must comply with traffic rules and speed limit requirement.

Check prior to operation

Prior to operation, check following items. Pay attention to importance of this check. However, perform all checks and necessary maintenance prior to operation.

Check item

Item	Key point
Steering handle	<ol style="list-style-type: none"> 1) Stability 2) Flexibility 3) No play or looseness along shaft
Brake	<ol style="list-style-type: none"> 1) Brake handle and brake pedal have correct play 2) No malfunctional brake 3) No oil leakage
Tyre	<ol style="list-style-type: none"> 1) Correct air pressure 2) Appropriate pattern 3) Neither crack nor cut
Fuel storage capacity	Available for planned mileage

Item	Key point
Light	Operable all lights, such as head light, tail light, brake light, panel light, turning light
Indicator light	High beam indicator light, neutral position indicator light, turning indicator light, gear indicator light
Horn and brake switch	Proper function
Machine oil	Correct Oil level
Throttle	<ol style="list-style-type: none"> 1. Throttle dragline has appropriate play 2. Feed fuel smoothly and cut off fuel supply rapidly
Clutch	<ol style="list-style-type: none"> 1. Appropriate tension 2. Proper lubrication
Drive chain	<ol style="list-style-type: none"> 1. Clutch dragline has appropriate play 2. Smooth operation

Start-up of engine

Check if fuel tank switch is in "ON" position and if engine flameout switch is in "⌚" position. Insert key in keyhole on ignition switch and turn it clockwise to "⌚" position. If your motorcycle is in neutral position, neutral position indicator on the panel will light.

Warning

Keep in mind: when starting up, set variable speed device to neutral position and hold clutch lever by both hands to avoid unexpected start-up arising from incorrect gearshift.

Engine will start when pressing the ignition button.

Caution

Idle time must be controlled to avoid overtime because long-time idle may overheat engine to cause damage for internal mechanical parts.

Warning

Never start engine in poor ventilation environment or room without ventilation equipment because carbon monoxide is virulent. When leaving the motorcycle alone, driver must turn off engine.

Running

Hold clutch lever firmly and step on gear-shift lever to enable 1st Shift; open the throttle slowly and release clutch lever slightly to start the motorcycle.

When to change to higher-level shift, accelerate firstly, then close the throttle, meanwhile holding clutch handle and press gear-shift lever to enable 2nd Shift. Release clutch handle slightly and open the throttle gently; by analogy, reach the shift at highest speed.

Warning

Prior to start up, return side stand to original position, in no case with other position.

In the case of variable speed gear

Variable speed gear enables the engine to run stably within normal running range. Variable speed ratio is especially selected according to the performance of the engine. Driver should select optimal shift according to driving conditions. At any time, the driver don't slide the motorcycle while releasing the clutch; otherwise danger may occur. Before decelerating, the driver decreases shift level to enable the engine to run within normal rev range.

Caution

At any shift level, rev must be not beyond red range.

Climbing up

- In the case of abrupt slope, the motorcycle might decelerate due to shortage of power. In this case, change to lower shift to enable the engine to run within normal power range. However, shift should be changed as soon as possible to prevent the motorcycle from decelerating rapidly.
- When going down along the slope, running resistance of the engine may Help brake as long as shift is changed to lower one.
- Keep in mind: don't run the engine beyond required speed range.

Brake and stop

- Turn throttle handle outwards to close throttle completely.
- Apply force on front brake handle and rear brake pedal uniformly.
- Change to lower shift to decelerate motorcycle.
- Hold clutch handle by both hands to change shift to neutral position, thus braking fully. Neutral position indicator on the panel lights.
- In the case of flat slope, lower speed shift is enabled to prevent the motorcycle from turning over arising from side stand which supports the motorcycle. However, shift must be set to neutral position prior to starting again.
- Set ignition switch to 'OFF' position to stop the engine.
- Take out the key.
- Lock reame head to ensure safety.



Warning

In the case of high speed, braking distance should extend additionally. You must estimate the distance from any vehicle or object to confirm if it is enough to brake.

Unskillful driver uses rear brake pedal easily to brake the motorcycle. This will accelerate brake system to wear out; thus braking distance becoming longer.

Using front brake or rear brake individually is very dangerous because this causes slipping and losing control. In the case of wet or smooth road surface.

Troubleshooting

Running in of new motorcycle

In Preface, we describe such fact that new motorcycle running in correctly can extend its service life, but also bring its performance into play sufficiently. Now, we will list correct running in methods.

Running speed

Table below lists recommended speed at each shift during running in.

1st gear	0 ~ 15km/h	2nd gear	10 ~ 20km/h
3rd gear	15 ~ 30km/h	4th gear	20 ~ 40km/h
	5th gear		30 ~ 50km/h

Rev variation of engine

Engine's rev shall be variable frequently, instead of constant rev. in this way, all components and parts can bear loads uniformly. They will cool down properly while unloading to grind in each other. During running in, the throttle may be opened more widely to accelerate, thus running in sufficiently and completely.

Avoid running at constant low speed

In the event that the engine runs at constant low speed, components and parts may wear out to cause improper fitting. As long as recommended Max speed isn't exceeded, the driver can enable each shift to accelerate the engine. However, highest-level throttle is inapplicable within initial 1000 km.

Circulate engine oil prior to starting

Prior to starting at high and low temperature, the engine should be able to run at idle speed sufficiently so that engine oil flows to all lubrication points.

First regular maintenance and check

Maintenance at initial 1000 km is most important. During running in, all components and parts in the engine have already been grinded in. Therefore, in this maintenance, each component / part should be readjusted or retightened and engine oil contaminated by running dust be replaced as well as filter element be cleaned to comply with initial 1000 km maintenance requirement, bring optimal performance of this motorcycle into play, and to extend service life.



Caution

Initial 1000 km maintenance shall be implemented in accordance with Section "Regular Maintenance" Pay special attention to "caution" and "Warning" in this section.

Use instruction for fuel and engine oil

Fule

Gasoline above 90# octane number shall be available. It is preferred to select lead free gasoline or low lead gasoline.

Notice

Lead free or low lead gasoline can extend service life of spark plug.

Fillup fuel



When opening this cover, insert the key in lockhole on the cover and turn the key clockwise till you cannot turn it; then take off the cover with the key. When reassembling the cover, align it along arrow direction and put it on the tank; then press it till you hear "click" sound; finally, take out the key.

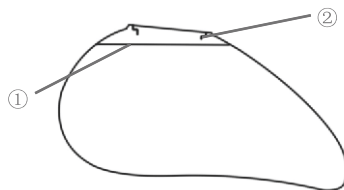

- ① Fuel level
- ② Fuel tank port

Notice

When washing motorcycle, never wash fuel tank with high-pressure water to prevent water from entering into the tank.

Warning

Never add fuel excessively to avoid overflow that can spread on the engine under high temperature. Fuel level ① cannot exceed the bottom of fuel tank port ② shown as the figure; otherwise heated fuel is expansible to overflow.

Before adding fuel, turn off the engine and turn the key to 'OFF' position. Never close to any fire.

Engine oil

High-quality four stroke engine oil can extend service life of engine. Please select and use "Four stroke engine oil for Motorcycle" especially developed and specified. Our authorized service centers can provide this oil. If this oil is unavailable, API SG our oil with SG 10W-40 viscosity is applicable; or substitutes are usable shown as table below according to local climate condition.

API attributive classification standard	
SG	High ↑ Low
SF	
SE	
SD	

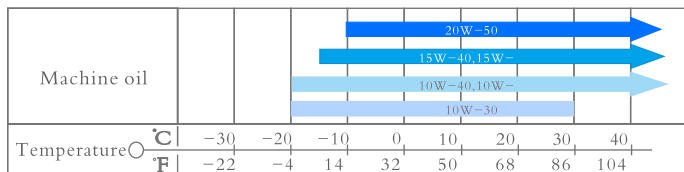

Warning

Fule, engine oil and axunge must preserved place of the children don't touch, and notice correspond to warning nameplate in container, or else have danger of harm health with people.

Regular maintenance

Table below shows all checks in regular maintenance. Check frequency is subject to operation months and running mileage of which the earlier is preferential. Intermediate inspection includes lubrication system and specified items.

If your motorcycle runs in harsh environment such as sand storm or a condition under which the throttle has to open widely, you should perform special maintenance to ensure its reliability. In this case, your distributor may provide you with further consultation. Because steering system, shock absorber and wheel axel are key parts, they must be serviced and maintained by specially trained technicians. For the sake of safety, we recommend this work be entrusted to your distributor.

Caution

In regular maintenance, some parts are replaced if necessary. We strongly recommend you use original parts or equivalent parts. Regardless of a mechanical expert or skillful technician, you must entrust the items marked with "*" to your distributor.

You may check all items without "*" mark.

Warning

New motorcycle grinding in correctly (initial 1000 km) is critical in order to ensure reliability and sound performance.

Pay attention to this regular maintenance for compliance with this Manual.

Regular maintenance table

Item	Check cycle	Initial 1000	Every 4000	Every 8000
	km	5	20	40
Battery	Months	Check	Check	—
*Nuts of cylinder cover and bolts		Tighten	Tighten	—
*Screws of cam shaft		Check	Check	—
Air filter		Every 3000 km		
* Valve clearance		Check	Check	—
* Spark plug		—	Check	—
* Fuel pipe		Check	Check	—
		Replace every 4 years		
* Machine oil		Replace at initial 1000 km; then every 3000 km		
* Oil filter screen (strainer)		Wash	Wash	—
* Exhaust catalyzer fitting		Check every year		

* EFI system	Check	Check	—
*Filter element of fuel switch	—	Check	Replacing
Drive chain	Check	Check	—
	Wash and lubricate it every 1000 km		
* Braking oil hose	Check	Check	—
	Replace every 4 years		
* Brake oils	Replace every 2 years		
* Brake	Check	Check	—
Tyre	Check	Check	—
* Steering gear	—	Check	—
* Front fork and rear shock absorber	Check	Check	—
* Bolts and nuts of body	Check	Check	—

Note: checks in table above include, as necessary, further cleaning, tightness, or replacement etc.

Regular lubrication table

Item \ Interval	Every 6000 km or 6 months	Every 12000km or 12 months
Throttle cable	Machine oil	—
Throttle handle	—	Lubricating grease
Clutch cable	Machine oil	—
Tachometer flexible shaft	—	Lubricating grease
Speedometer flexible shaft	—	Lubricating grease
Speedometer gear box	—	Lubricating grease
Drive chain	Lubricate every 1000 km	
Brake pedal shaft	Lubricating grease or engine oil	—
* Cam shaft of brake	—	Lubricating grease
* Steering bearing	Lubricate every 2 years or 20000 km	
* Bearing bush, rear cradle	Lubricate every 2 years or 20000 km	



Notice

For the details of relative maintenance centers and service items, please refer to the Maintenance & Service Manual. Tayo company suggests you to go to the authorized dealers for maintenance and service.

Attention: All the necessary maintenance and service shall be confirmed in the Maintenance & Service Manual, which can indicate that you have made regular maintenance for your vehicle.

Battery

The storage battery is placed on the right side. Open the cover on the right side, you can check it. It is a common type storage battery. When the liquid level of the battery is lower than the lowest scale line, the battery shall be supplied with distilled water.

Check the battery liquid level

1. Right side cover
2. Highest scale line of liquid level
3. Lowest scale line of liquid level

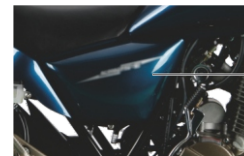

When connecting two poles of storage battery by using battery lead, correspond positive and negative poles correctly: red lead to positive pole and black lead to negative pole; in the event of incorrect connection, this may cause damage to charging system and storage battery itself.

Air filter

This motorcycle is equipped with air filter in which element is made of plastic foam. In the event that the filter is blocked by dust, the resistance at air inlet increases, accordingly, output power decreases; as a result, fuel consumption increases.

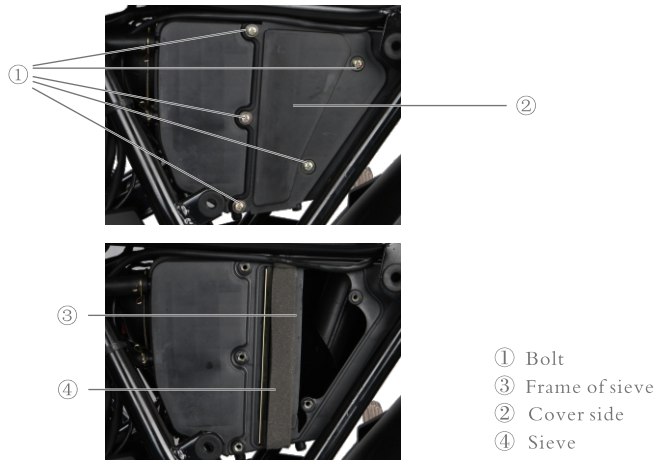

- (1) Take off left side cover.
- (2) Unscrew outside cover of the filter and take off the cover.
- (3) Take out element holder.
- (4) Separate element from its holder.

Caution

In the case of heavy dust, you should clean or replace filter element frequently, instead of handling of the filter element repair needed.

Cleaning element

Cleaning method is as follows:

- (1) Pour incombustible cleaning solution into an properly- sized pan and immerse the element into the liquid.
- (2) Squeeze the element by both hands to avoid brakeage.
- (3) Immerse the element in machine oil, and squeeze out residual oil to make the element keep oily damp slightly.
- (4) Reassemble the element in inverse sequence, and confirm it for fitting in place and properly sealing.

Caution

Before or during cleaning, check the element for any crack. If any, replace it.

Spark plug

Remove accumulated carbon attaching on spark plug by using hard iron wire or steel needle, and adjust the clearance of spark plug by using feeler gauge to be between 0.6 ~ 0.7 mm.

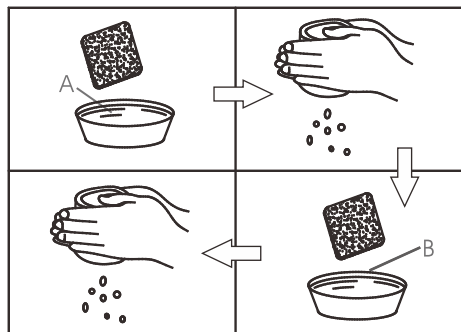

A. Incombustible cleaning solution

B. Vehicle oil

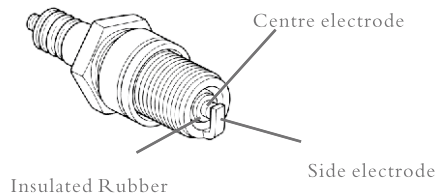

When removing the carbon, check two kinds of color at ceramic tip of spark plug, which indicate whether standard spark plug is in good condition or not. If spark plug shows wet black, high-pressure thermal spark plug is applicable. A spark plug in normal working condition shows light brown. If it shows white and shines, this indicates that it is working in overheat condition. In this case, it should be replaced with cold type spark plug.

Notice

In the case of heavy dust, check, clean and replace filter element at shorter interval (mileage or time). In the event of such defect as block, breakage and etc, replace it immediately, instead of waiting till maintenance time. In the absence of filter element, starting engine may wear out the engine. Pay special attention to filter element because mechanical life depends on it.

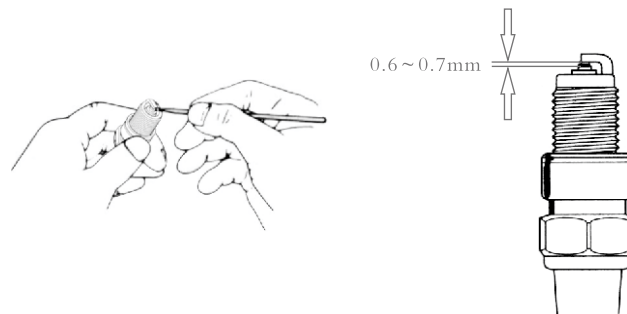

Replacement guideline of spark plug

PORCH	NHSP	Remark
D7RC	D7RTC	If standard spark plug shows moisture state, use this spark plug.
D8RC	D8RTC	Standard spark plug
D9RC	D9RTC	If standard spark plug shows overheat state, use this spark plug.

Caution

Spark plug cannot be tightened excessively or screwed incorrectly to prevent from damage to thread on cylinder head. When disassembling spark plug, don't let foreign matter enter into engine via spark plug.

Standard spark plug used in this motorcycle is especially selected according to its working scope. In the event that spark plug shows different color from standard one, you'd better consult your distributor before replacing with a spark plug within different heat-resistant range, because inappropriate spark plug may damage engine badly.

In the event that other spark plug causes difficult start-up, please consult your distributor to select right spark plug.

Machine oil

Service life of engine depends on high-quality machine oil and periodical replacement. In maintenance work, two key points are: check machine oil level every day and periodical replacement.

Machine oil level check

- ① Oil hole cap
- ② Upper limit scale on dipstick
- ③ Lower limit scale on dipstick

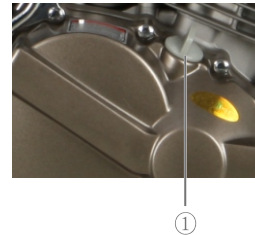

When checking oil level, support motorcycle on flat floor by means of main stand; make dipstick contact pouring orifice, but don't screw dipstick; however, oil level should be between upper limit ② and lower limit ③.

⚠ Caution

If dipstick indicates low oil level, this shows that oil capacity is in shortage. In this case, never start up engine. However, adding oil till upper limit is reached.

Replacing machine oil and cleaning filter

Replacing machine oil should be performed when engine is in heat condition so that old oil may be discharged easily and completely. Oil replacement sequence is as follows:

- (1) Support motorcycle on flat floor by means of main stand.
- (2) Take out oil hole cap.
- (3) Unscrew oil drain plug on the bottom of engine to drain old oil completely.

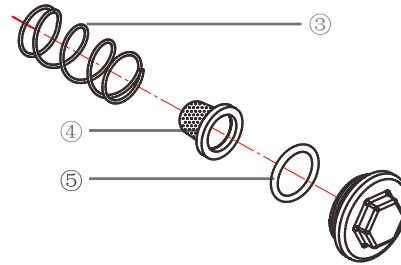
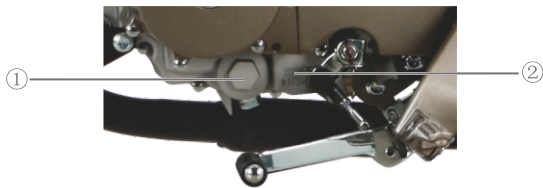

①. Filter cap ②. Oil drain plug ③. Spring

④. Filter screen ⑤. Seal ring

- (4) Disassemble filter cap and take out filter screen.
- (5) Before reassembling filter cap, check spring and sealing ring of filter element.

⚠ Caution

When cleaning and washing filter screen each time, replace sealing ring.

⚠ Caution

When cleaning and washing filter screen each time, replace sealing ring.

- (6) Reassemble filter screen, but don't screw it down excessively.
- (7) Hour about 900,l new machine oil via oil filling port (initial 1000ml for new machine), and then screw the cover of oil filling port slightly.
- (8) Start up engine and make it run at idle speed for several minutes.

 **Caution**

Double check filter cap for oil leakage.

- (9) Turn off engine and wait 1 min, than check oil level by using dipstick. If low oil level, add oil till correct oil level is reached.

 **Caution**

Please use recommended machine oil listed in “Use Instruction for Fuel & Machine Oil” .

EFI system

In order to remain low fuel consumption, the air-fuel ratio can be controlled accurately to be 14:7 by the EFI system under different riding circumstance. EFI system specification is already set prior to ex-work. You just pay attention to two points: idle speed and clea rance between steel cables of throttle.

Adjustment of idle speed

- (1) Start up engine to idle it till it warms up completely.
- (2) After engine warms up, close throttle and adjust left and right knobs for screw ② to keep rev between 1300 ~ 1500 rpm.

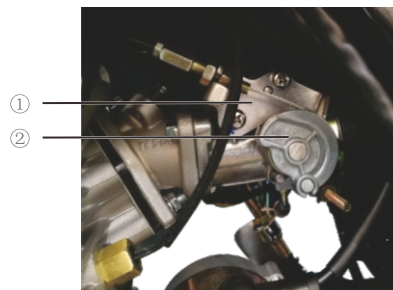

① EFI system ② Adjust screw

 **Caution**

Adjust idle speed when engine is in warm-up condition.

Adjustment of throttle dragline

Adjustment step

- (1) Unscrew locking nuts ①.
- (2) Turn screw ② to adjust clearance of dragline to reach between 0.5 ~ 1.0mm.
- (3) After adjusting, tighten locking nuts ①.

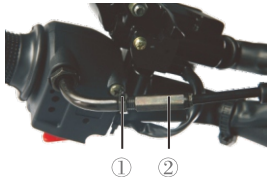

① Locking nuts ② Screw

Warning

After adjustment of clearance of throttle is finished, check throttle control handle for function. No adjustment increases idle speed of engine; furthermore throttle control handle is able to return to close position automatically.

Clutch

Adjustment method of clearance ① of clutch dragline is as follows: after holding clutch handle, there is 4 mm clearance before feeling elastic force clearly. If not, you may make adjustment as follows:

Unscrew nut ②, turn and adjust screw ③, and turn it clockwise till you cannot turn it anymore. Unscrew locking nut ⑥, and turn adjusting nut ⑤ forwards and backwards to make clearance of handle reach 4 mm more or less. Perform fine adjustment by using handle adjustment screw ③; after all adjustments are finished, lock nut ② and ⑥ and sleeve tube ④.



- ① Clearance of clutch dragline ④ Sleeve tube
② Nut
③ Adjust screw



- ⑤ Adjust nut
⑥ Locking nut

Transmission chain

Regular check of drive chain includes:

- (1) Loose chain pin.
- (2) Damification of roller.
- (3) Dry or rust chain link.
- (4) Kink or stick link.
- (5) Excessive wear.
- (6) Adjusting incorrect link.

Warning

Any damage or loosening of steering stem bearing can cause danger. Add a box or a stow-wood under the engine to keep front wheel leave the ground and then hold the bottom of the front fork shaking.

If drive chain has defects above, these defects arise out of worn chain wheel probably. So check chain wheel as follows:

- (1) Excessively worn wheel teeth.
- (2) Broken or damaged wheel teeth.
- (3) Loose fixing nuts on chain wheel.

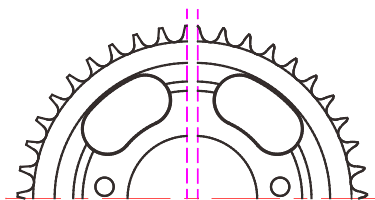

Fine teeth

Excessively worn tooth

Cleanness and apply oil of transmission chain

Contaminated drive chain speeds up wearing itself, but also damages chain wheel. Therefore, after washing in cleaning solution, lubricate drive chain.



Adjusting drive chain

Adjust drive chain to make it keep proper tension. According to driving condition, adjustment frequency should be more than regular maintenance frequency.

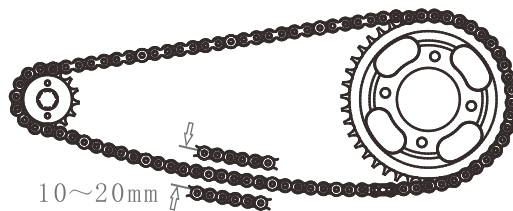

Warning

Too loose chain may cause serious accident and damage engine.

Please adjust drive chain as follows:

- (1) Support motorcycle by means of main stand.
- (2) Unscrew nuts on rear shaft.
- (3) Unscrew locking nut.
- (4) Turn left and right adjusting bolts to adjust tension of the chain; meanwhile pay attention to alignment between front and rear chain wheels. To easily operate, mark rear wheel and each adjuster for alignment and reference.

Align mark and adjust chain to reach 12 – 20 mm looseness; then tighten nut(s) on rear shaft; then tighten locking nut(s) on adjusting bolt(s) and make final check

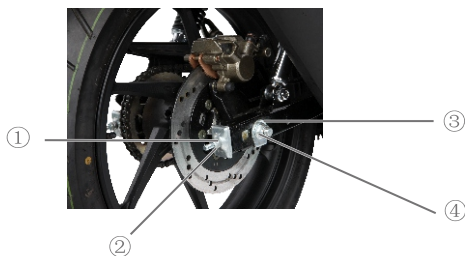

① Locking nut

③ Mark

② Adjusting bolt(s) of drive chain

④ Nut on rear shaft

Notice

When replacing drive chain, check front and rear chain wheels for wearing; if necessary, replace chain wheels.

Make sure the open direction of its locking ring is opposite to the movement direction of chain when fixing drive chain.

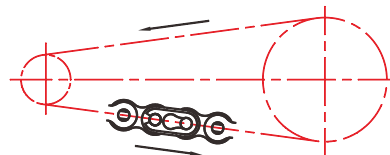

Caution

This drive chain is made of special raw materials. Replace it with our original parts (428 H, 118pitch/42teeth). Other brands may cause malfunction.

Rear spring adjustment of shock absorber

Buffer spring of rear shock absorber may be adjusted according to driver's desire, bearing condition, operation mode and road condition etc. Adjust to stepless position, you can use the spanner to adjust the rear absorbers, the upper is most soft, and the underside is hard, we already adjusted the right position before come out factory.

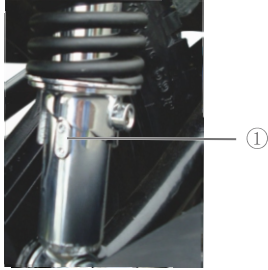

Warning

Left and right buffer springs must be adjusted to same position. Improper adjustment may impact on operational stability.

Maintenance and service of silencer

To extend service life of silencer, you'd better maintain and service silencer regularly as follows:

1. Disassemble silencer and block drain hole at lowest point in the middle of the silencer (recommend adhesive tape);
2. Add 50ml anti-rust oil at flange between silencer and engine; shock silencer to make the oil flow into cylinder uniformly; then assemble silencer.

3. After starting engine, because silencer's temperature rises gradually, anti-rust oil will volatilize due to heating; in this case, blue smoke appears from the tail of silencer. However, the blue smoke disappears after having driven 20 km. Unblock drain hole upon disappearance of blue smoke.

4. We recommend new motorcycle is lubricated prior to putting into service, subsequently every half year. In case of unavailable anti-rust oil, four troke engine oil is applicable.

Brake system

This motorcycle uses front and rear disc brake will play critical important role in safe driving. Keep in mind: regularly check braking system. However, only authorized distributors are qualified for this check.

CBS brake

In braking system, daily check includes:

- (1) Check front and rear wheel. Make sure there's no oil leakage.
- (2) Oil pipe for oil leakage or crack;
- (3) Brake disk for oil consumption;
- (4) Brake handle for correct travel and rigidity;
- (5) Brake pedal must have correct braking stroke while position returning should be flexible.

Warning

If braking system or brake disk needs repair, we strongly recommend your distributor to do this work for you. Because your distributor has complete tools and skillful technology, you will get most safe and economic repair.

Caution

Disk braking system is based on high-pressure brake. For the sake of safety, you must replace oil pipe and brake oil strictly at interval time specified in Maintenance section in this 'Manual'

Warning

Don't start your motorcycle to run just after replacing with new brake disk. You'd better hold and release brake handle in several cycles to make brake disk attach closely; thus resuming normal holding force; and to brake oil circulate stably.

Brake oil

Pay attention to oil level in brake oil tank. If oil level approaching LOWER LEVEL, add a little specified brake oil. When brake disk wears out, brake oil in the tank will automatically flow into oil pipe, thus oil level drops. However, brake oil supplement is one of the key items in regular maintenance.



① UPPER LEVEL ② LOWER LEVEL

Warning

Brake oil is harmful to human health, so you must avoid accident ingestion and eye(s) or skin contact. In case of drink by accident, be mandatory to vomit; in case of eye(s) or skin contact, wash the affected parts large quantity of clean water in time and then have medical treatment.

Caution

This motorcycle uses ethanol-based brake oil that cannot mix with silicic acid based or petroleum based liquid; otherwise braking system may be damaged badly. Never use oil which to be stored in the container without cover. Never use residual brake oil coming from last maintenance because old oil may absorb moisture in the air. Only DOT4 brake oil is available for this motorcycle. Due to corrosive nature, don't let brake oil spill on painted surface or plastic surface.

Brake disk

Checking front and rear wheel brakes key points include degree of wear of the disk ①. If its wear is beyond wear limit, replace new brake disk.

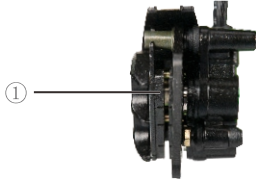

Brake disk is an important part of CBS brake, Check if its thickness is within safe scope. When the disk is worn out 1mm or more, must replace with new one.



Warning

No grease or dirt attaches on friction surface of a brake disk to avoid deterioration of braking quality and safety accident.

Caution

Too low level in brake oil tank may result in longer braking distance. In this case, you must adjust your operation mode to meet driving performance requirement meanwhile you should replace the brake disk or add brake oil as soon as possible. We recommend you to contact our distributor for the disk or the oil.

CBS brake

Adjust rear brake pedal

When stepping on rear brake pedal, front and rear wheel start braking at the same time. The braking force of front and rear is 3:7. When right hand brake is grabbed only, front wheel is braked and rear wheel is not braked.

Adjust rear brake pedal

To adjust the stroke of rear brake pedal, disassemble first the pin of lower pivot and adjust the pedal to most comfortable position. Then switch the adjustable nut (1) on the pushing rod. Keep free stroke between 5–10mm. (Fig below: brake pedal and adjustable nut)



Brake indicator switch

Front brake lever light switch

Front brake indicator switch ① is located under brake handle. Unscrew screw and move the switch forwards and backwards to find appropriate positioning point at which brake indicator lights just before applying force on the handle.

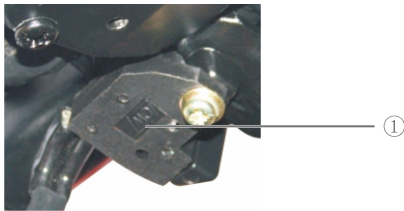

Rear brake lever light switch

Tail lamp switch (1) is on the top of main pump body. When oil pressure inside the tube reaches 0.1~0.57Mpa, the tail lamp is on.



Tyre

Service life of tyre and driving comfortability and safety, to the most extent, depend on tyre condition and air pressure in it. Incorrect air pressure may cause unstable driving or damage tyre, thus resulting in an accident.

Items to be regularly checked include air pressure and pattern. In order to ensure highest safety and longest service life, frequent check is needed, besides regular check.

Caution

Regularly check air pressure of tyre twice per month at least; mandatory check prior to long distance.

Notice

However, fuel consumption isn't dependent on tyre pressure. Contrarily, low tyre pressure will increase contact area between tyre and ground, so fuel consumption increases; moreover service life of tyre is shorten.

Tire pressure

In the case of insufficient air pressure, this speeds up tyre wearing, but also impacts on driving stability. Insufficient air pressure may cause difficult turning; by contraries, too high air pressure reduces tyre's contact area to make wheels slip; thus losing control. Air pressure in a tyre must be kept within specified range. Air pressure is adjustable at low temperature.

Air pressure under cold condition

	Single person	Double – person
Front wheel	1.50kg/cm ² 150 kPa	1.75kg/cm ² 175 kPa
Rear wheel	2.00kg/cm ² 200 kPa	2.25kg/cm ² 225 kPa

Warning

In this motorcycle, standard tyre is:

Front wheel	100/80–17 200kpa	90/90–17 200kpa
	3.0–17 200kpa	
Rear wheel	130/70–17 225kpa	

Any tyre beyond standard may cause accident. We strongly recommend we select standard tyre.

Air pressure and wearing will play critical important role in motorcycle's function and safety. Therefore, you must check air pressure and pattern frequently.

Tyre damage

You should check tire for damage and embedded foreign matters etc frequently.

During running, any abnormal vibration indicates that tire might be damaged or other part damaged or motorcycle is running on kerb (or curb). In this case, driving performance changes abnormally, for example deviation from running direction.

In such case, you must decelerate to stop immediately and check wheels and tires. If necessary, you contact your distributor and have trained technician(s) give a solution.

Warning

Damaged tyre may threaten personal safety and cause injury.

Notice

All the wheels or tires taken off from the vehicle shall be stored in a cool & dry place and keep away from strong light. Never let tires touch oil and gasoline.

New wheel and tyre

Only your distributor or professionally trained technician(s) is qualified for installation of new wheel and tire. Any operation without authority might cause subsequent damage and safety risk.

We recommend you don't use retread because it has different internal structure and is aged partially to reduce operation safety of motorcycle.

We recommend prototype (original) wheel and tire for your motorcycle. Due to some factors such as machining tolerance and etc, wheels might contact body to cause serious accident in despite of same nominal dimension. It is impossible to assess unapproved wheel and tire, so unable to assure safety.

Regarding correct selection of wheel and tire, please consult your distributor.

Correct wheel and tire may impact different system. To maintain good reliability, same structure and pattern are necessary in tires selection. When there is something wrong with the tires, you should carry out troubleshooting as soon as possible.

Electric system

Replacement of bulb

Rated power of each bulb is shown as Table below. Replace damaged bulb with one with same rated power. Different rated power may cause overload in circuit system and shorten service life of bulb.

Headlight	12V	35W
Tail / brake light	12V	5/21W
Indicator light	12V	0.6W
Position light	12V	5W

Replace bulb of front light



1. Disassembly the bolts of headlight①
2. Disassembly the bolts of headlight②
3. Take off bulb holder of front light③
4. Replace with new bulb④

Caution

Keep front light bulb clean and dust free to extend its service life. When replacing, wipe off grease and dust using clean cloth.

Replace bulbs of front and rear indicator lights



The motorcycle is made of LED tail light and brake lights ,it is durable than usual lights,because of its special construction ,if you meet any exceptional problems,please do not fix it by yourself and contact your local our agent to deal with it .

Caution

When mounting lampshades, don't tighten fastening screws excessively; otherwise lampshades break.

Taillight and stoplight is replacing

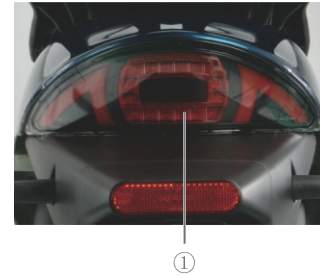

The motorcycle is made of LED tail light and brake lights ① ,it is durable than usual lights,because of its special construction ,if you meet any exceptional problems,please do not fix it by yourself and contact your local our agent to deal with it .

Caution

Bulbs and lights play important roles in vehicle safety. Therefore, you must pay attention to the operation in this respect. If you aren't familiar with this work or have no detail information given in this Manual, please have your distributor perform this work.

Notice

Prior to operation of any electrical component, you must turn it off to avoid short circuit. When replacing a bulb, you must comply with manufacturer's instruction to avoid injury and damage.

Cartridge fuse

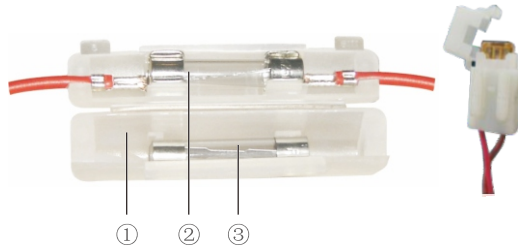

- ① Cover of cartridge fuse
- ② Cartridge fuse
- ③ Standby cartridge fuse

Cartridge fuse is located outside storage battery, There's only one on main cable. There are two on vise cable(Yellow one is 5A; blue one is 15A). In the event of flameout or circuit disconnection, you must check cartridge fuse firstly.

Caution

Select cartridge fuse having correct rated current. No substitute is allowable, such as aluminum foil or iron wire etc. If cartridge fuse blows out in short time frequently, this indicates that malfunction exists in electrical system. In this case, you must contact your distributor for repair.

Use instruction for storage battery

1 New storage battery

1.1 Adding electrolyte

1.1.1 Check storage battery for appearance, crack and scratch on casing, bending and deformation on terminal.

1.1.2 Put battery on horizontal plane, tear down the sealing tape.

1.1.3 Take out the electrolyte, remove the sealing plug, invert the electrolyte, aim to the filling port, press hard and brake the thin film and start filling liquid.

1.1.4 After filling electrolyte, press back the sealing plug until the top of battery is flat, Clean the surface of batter with clear water and dry it with cloth.

1.1.5 After the battery is added with electrolyte, leave it 30min, then start engine. If possible, charge it in 3 ~ 5 hrs to have better starting performance and extend its service life. Before putting into use, charge the battery in 3 ~ 5 hrs after not having used it for a long time at low temperature or as from ex-factory

1.2 Installation

1.2.1 Firstly connect positive (+) pole (red mark), then negative (-) pole. Never connect poles incorrectly, otherwise this may damage regulated rectifier.

1.2.2 Tighten bolts, then coat grease or vaseline on bolts, nuts and terminals.

2 Use and maintenance

2.1 Each starting time cannot exceed 5s. If several startings fails in succession, check fuel supply system and starting and ignition system.

2.2 Following cases may cause insufficient discharge or charge to shorten service life.

- (1) Frequent starting; short driving distance.
- (2) Running at low speed for long time.
- (3) After actuating brake handle or brake pedal, brake indicator lights stably.
- (4) Electrical appliance or bulb beyond rated power.

2.3 In the case of difficult start-up, dimmish light or horn at low sound level, charge the battery immediately.

2.4 If you want to leave your motorcycle in non-service state for a long time, you'd better charge the battery prior to service stop, and then charge it monthly.

2.5 Charge

2.5.1 Only especially designed charger is available for storage battery in this motorcycle. Sealing plug can not be removed when battery is recharging, always ventilate the environment meanwhile no naked fire is allowable.

2.5.2 Charging method includes standard charging method and fast charging method. Unless there is an emergency, standard method is available as possible to extend service life of storage battery.

	Current	Time
Standard charging	0.7A	5-15 Hour
Fast charging:	3A	Not more than 30 min

2.5.3 During charging, if electrolyte's temperature exceeds 45°C, stop charging immediately. After cooling down, continue charging again. When bubbles occurs in the battery, finish charging. Press (tighten) hole plug, then clean the battery.

3 Precautions

3.1 When using and charging storage battery, explosive gas may form. Therefore, no battery approaches naked fire. In addition. Short-circuit and looseness at both poles must be avoided to prevent the battery from explosion.

3.2 Electrolyte contains strong acid. Therefore, it must avoid skin, eye and clothing. In the event of contact, wash affected part using large quantity of clean water. In case of accident ingestion, drink water or milk in large quantity; if necessary, go to see doctor.

3.3 Keep electrolyte in a place where children are inaccessible to.

3.4 In the case of guard against theft and alarm system, we recommend the system especially designed by our company, because other systems might cause malfunction of circuit system, even damage storage battery, igniter and regulated rectifier etc.

Caution

The replaced old batteries shall be reclaimed by Tayo authorized service centers or be disposed by recycle centers. The battery containing acidic liquid shall be vertically stored or shipped.

Troubleshooting

Troubleshooting

If engine cannot start up, please check following items

- (1) Check if side stand is on stop position.
- (2) Fuel level in the tank is correct.
- (3) Pull the high pressure tube out from spray cap, turn fuel tank switch to "U" position and turn ignition switch to "ON" position. then check if fuel flows out smoothly.
- (4) If fuel can enter spray cap is confirmed , check ignition system.
- (5) Fix spark plug on body, turn ignition switch to "ON"position, and set flameout switch to "Q"position, then press start button. If ignition system is in normal condition, blue spark occurs between two poles of spark plug. If no spark occurs, please contact your distributor for repair.

Warning

No fuel flows on the ground; any fuel must be collected in a container. No fuel approaches engine and exhaust pipe at high temperature. This check may be performed as far from fire as possible. Meanwhile no fuel approaches fire or heat.

Don't fix spark plug close to cylinder head when performing the check, because vaporising fuel in the cylinder is ignited by spark probably to cause a fire.

To minimize possibility of electric shock, metal part of spark plug casing should attach to bared metal part of body. To avoid electric shock, a person suffering heart disease or wearing cardiac frequency modulator is forbidden from doing this work.

Low output power from engine

- (1) Check fuel supply system of fuel tank.
- (2) Check ignition time of ignition system.
- (3) Check idle speed of engine.

Caution

Prior to troubleshooting, consult your distributor for solution.

Specification table

Dimension and weight

Length	1980mm
Width	760mm
Height	1080mm
Wheelbase	1310 mm
Ground clearance	170mm
Integrated mass	130kg
Mass load (including passenger)	150kg

Driving system

Turning diameter	3.2m
Front tire	3.0-17 200 kpa 100/80-17 200kpa 90/90-17 200kpa
Rear tire	130/70-17 225kpa

Engine and transmission device system

Type	Single cylinder, Wind cooling and Four stroke	
Stroke	49.5 mm	
Cylinder diameter	56.5 mm	
Discharge capacity	124 mL	
Compression ratio	9.6:1	
Starter mode	Electric / Kick	
Lubrication mode	Pressure and splash	
Clutch	Grade retard clutch	
Transmission	International 5-gears	
Gear ratio	1st shift	3.083
	2nd shift	1.882
	3rd shift	1.400
	4th shift	1.174
	5th shift	0.960

Main performance index

Fuel consumption at economic speed	≤2.4L/100km
Max speed	≥90km/h
Climbing capacity	≥20°
Braking distance	≤7m(V=30km/h)
Initial vertical gradient at dipped beam	1° ~ -1.5°

Capacity

Fuel tank (total capacity)	14.5 L
Spare capacity	3.5 L
Engine oil capacity	1000 mL

Electrical system

Ignition mode	CDI
Spark plug model	CPR6E
Battery	12V6 Ah
Fuse size	15A, 5A
Front light size	12V,35W
Position light size	12V,5W
Tail / brake light size	12V,5/21W
Indicator lights	12V, 0.6 W

Circuit diagram

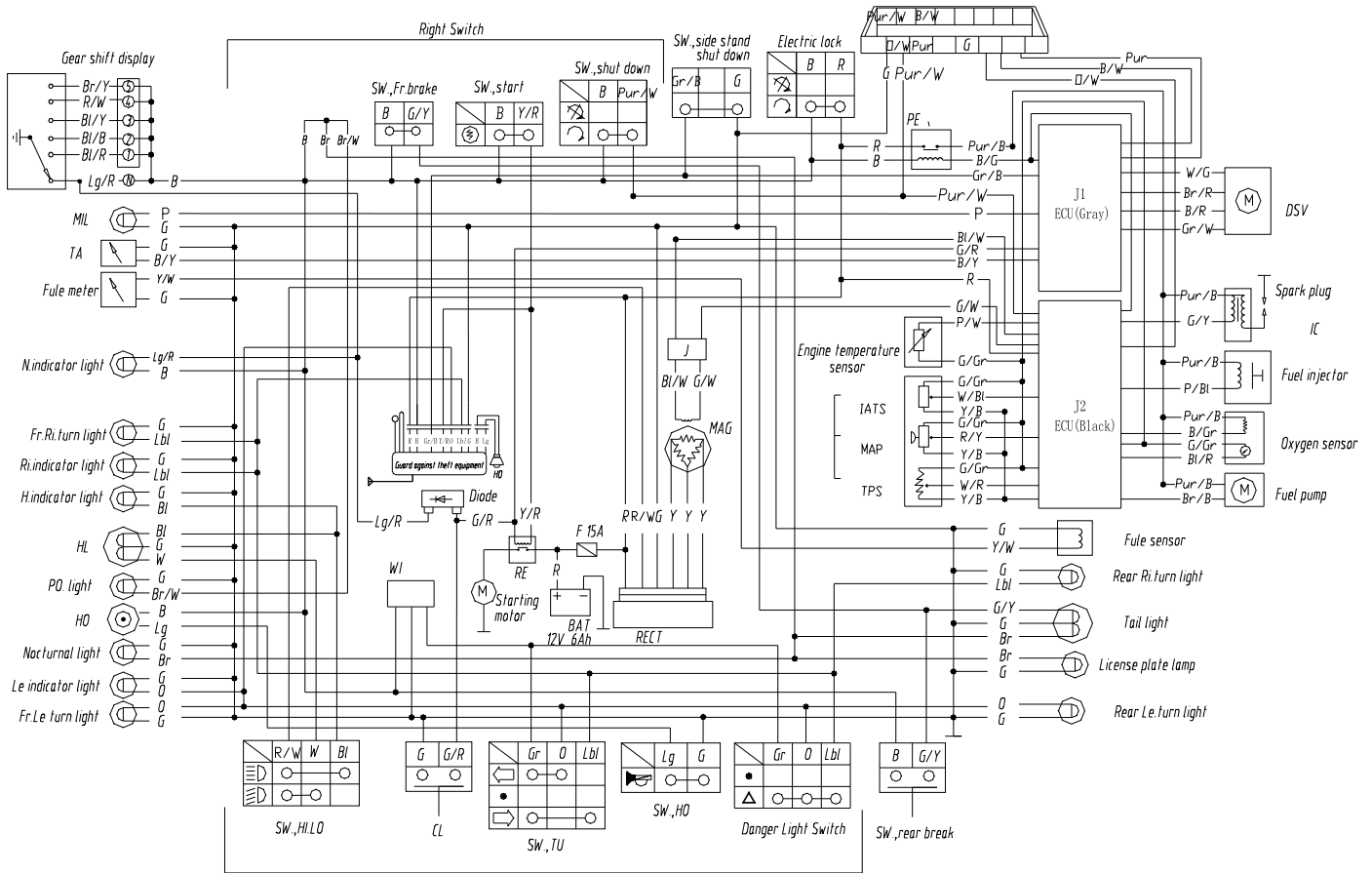

Left Switch

Abbreviation Form

Lead color	Letter symbol	Lead color	Letter symbol	Lead color	Letter symbol
Red	R	Light blue	Lbl	Green with red	G/R
Yellow	Y	Orange	O	Black with white	B/W
Blue	Bl	Light green	Lg	Blue with white	Bl/W
White	W	Pink	P	Brwon with White	Br/W
Brwon	Br	Gray	Gr	Yellow with White	Y/W
Black	B	Yellow with black	Y/B	Light green with red	Lg/R
Green	G	Yellow with green	Y/G	Yellow with red	Y/R

Name	Letter symbol	Name	Letter symbol	Name	Letter symbol
High	HI	Battery	BAT	Switch	SW
Low	LO	Fuse	F	Button switch	BS
Tail light	TL	Tachometer	TA	position	PO
Signal light	SL	Magneto	MAG	Neutral	N
Wink	WI	Clutch	CL	Ignition	IG
Horn	HO	Ignition coil	IC	idling solenoid valve	DSV
Rectifier	RECT	Relay	RE	Headlight	HL